

Windjammer V

Owner's Manual

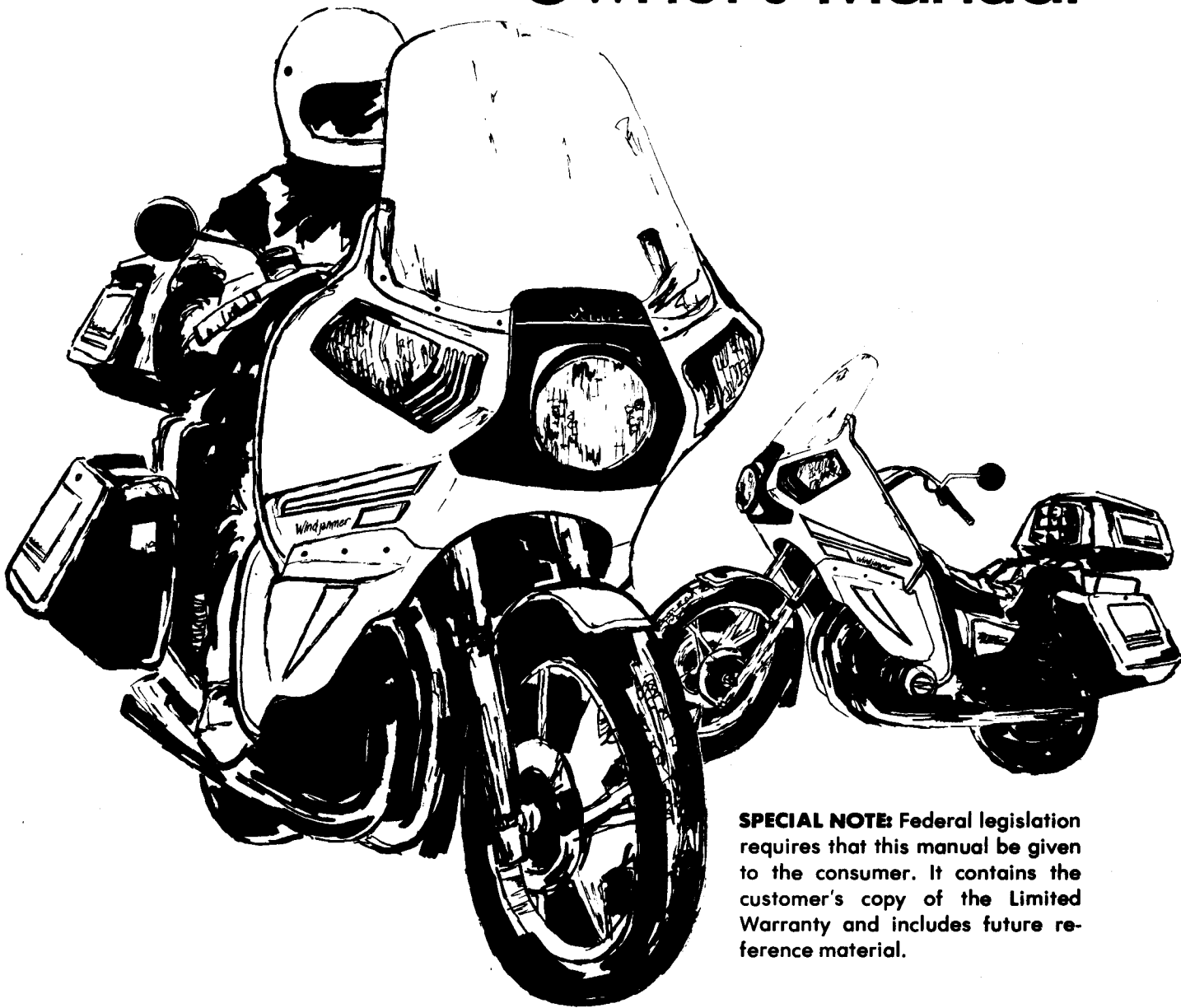

SPECIAL NOTE: Federal legislation requires that this manual be given to the consumer. It contains the customer's copy of the Limited Warranty and includes future reference material.

Vetter



Vetter Corporation, Rantoul, Illinois 61866 217/893-9300

Table of Contents

INTRODUCTION.....	3
WINDJAMMER V NOMENCLATURE GUIDE	4
ENGINE GUARDS.....	5
WINDSHIELD INSTALLATION INSTRUCTIONS	5
FINAL ADJUSTMENTS	7
TROUBLESHOOTING	8
MAINTENANCE.....	8
WARRANTY.....	10

Introduction

This manual contains important information regarding the proper installation, safe operation, and maintenance of your Windjammer V fairing. We urge you to read this manual completely, understand all components of your fairing and follow the recommendations to obtain the most trouble-free and enjoyable operation of your fairing.

In this manual and in the mounting instructions, statements preceded by the following words are of special significance:

WARNING: means that there is the possibility of personal injury to yourself and others.

CAUTION: means that there is the possibility of damage to the fairing and related components.

NOTE: indicates points of particular interest for more efficient and convenient installation and operation.

We recommend that you take particular notice of these items when reading this manual and the mounting instructions.

The intent of this manual is to insure that your Vetter fairing is properly installed and to provide necessary maintenance information — PLEASE USE IT! First, we recommend that as you unpack your fairing you use page 4 to study and recognize the various parts. Second, we recommend that you study your Hardware Mounting Instructions included with the hardware or adaptor kit and insert them

into this manual along with all other option instructions for easy reference. Working straight through the Mounting Instructions is a way of assuring that nothing is overlooked or forgotten.

As you are following the instructions, double check the following points as they are critical:

1. Carefully check wiring color codes.
2. Always install rubber washers between steel washers and the fairing.
3. Check for clearance and tighten all bolts before operating your motorcycle with the newly installed fairing.
4. Periodically check and retighten all bolts and clamps after installation.

SPECIAL NOTE: Vetter Corporation reserves the right to make changes in design and specifications, and/or to make additions to or improvements in its products without imposing any obligations upon itself to add or install them on products previously manufactured or sold.

© Vetter Corporation
January 1, 1981

Windjammer V Nomenclature Guide

INTERIOR

- Ear 1.
- Headlight adjustment knob 2.
- Pocket edging 3.
- Pocket tonneau 4.
- Locking tonneau 5.
- Horseshoe 6.
- Serial no. plate 7.
- Cigarette lighter hole 8.
- Lower mounting hole 9.
- External wiring harness 10. with fitted ends
- External wiring harness 11. without fitted ends
- Internal wiring harness 12.
- Horn mounting holes 13.
- Hardware mounting holes 14.

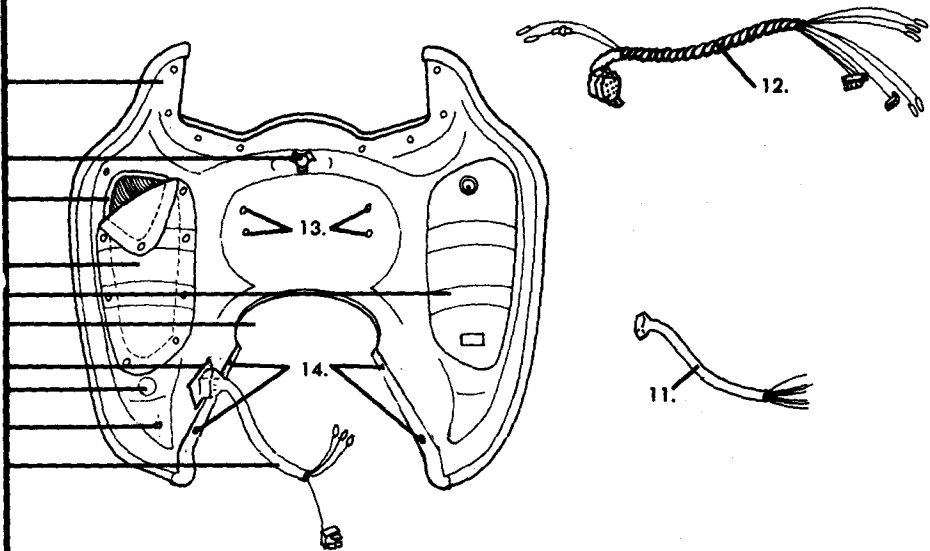

EXTERIOR

- Windshield 1.
- Leading Edge Light (LEL) 2.
- Windshield foam tape 3.
- LEL socket 4.
- Headlight mask 5.
- Headlight nacelle 6.
- Quartz headlight 7.
- Headlight ring 8.
- Lowers hole plug 9.
- Chrome vinyl edging 10.
- Nose 11.
- Chin 12.
- Headlight extension 13.
- Standard striping 14.

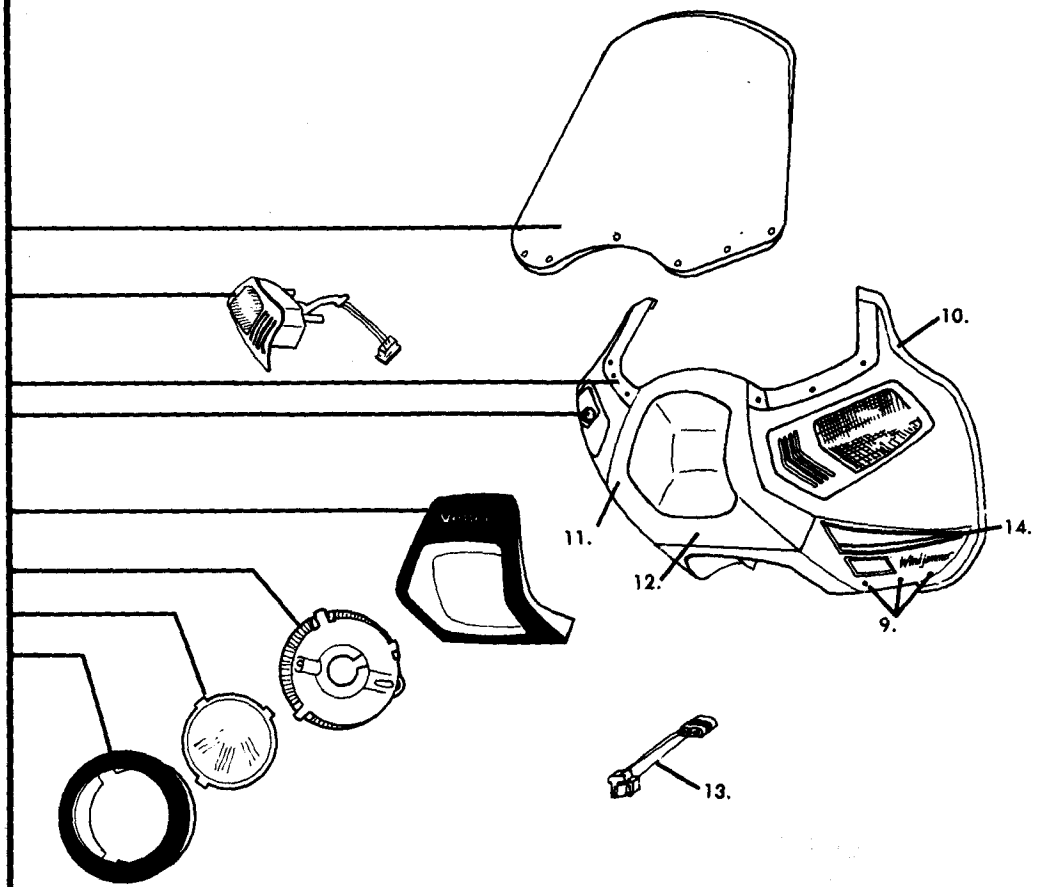

NOTE: All options are dealer or customer installed.

Engine Guards

Before mounting your Windjammer V hardware with an engine guard, check to see that the mounting bracket can be positioned securely to the frame without interference from the engine guard. To do this:

1. Mark the position of the upper engine guard mount on the motorcycle frame.
2. Remove the engine guard and position the fairing hardware bracket on the frame. The hardware should clear all marks which located the engine guard.

CAUTION: If it is obvious that the hardware bracket and engine guard cannot be used together, **DO NOT** attempt to mount the fairing with the engine guard. If there is no apparent interference, continue with the appropriate section in the hardware mounting instructions.

Certain closed loop type engine guards

can be used on the following motorcycles by obtaining an Engine Guard Adaptor Kit, part number 150 010 604, through your Vetter dealer:

Honda - CB350, 360, 450, 500, 550, 650, 750K1-K6

Kawasaki - KH400, 500, KZ900, 1000

Yamaha - RD350

Complete instructions are included in the Engine Guard Adaptor Kit.

WARNING: Cutting any part of the mounting bracket on any motorcycle not listed above, or not following the engine guard adaptor instructions will result in structural damage to the bracket, and subsequently, to the fairing.

NOTE: Welding and/or cutting (except when specified) will void the warranty.

Windshield Installation

After your Vetter fairing hardware has been installed and the fairing has been mounted, the next step is to mount the windshield. There are two sets of instructions packaged with the windshield; you may use the one titled "Windjammer V", or the instructions below.

A properly installed windshield is essential for safe use of the fairing. Six (6) of the windshield bolts are nylon and overtightening will result in bolt failures. Please note that the two top fasteners are clips instead of nylon bolts.

1. Using a nylon bolt, puncture the foam tape at each of the hole locations.
2. The two clips supplied should be positioned on the windshield 118 mm (4 5/8") above the upper-most bolt hole on the windshield.

NOTE: For reasons of structural strength, the windshield must

be "preloaded" (slightly bent) before the top holes in the fairing will line up with the clip stud.

3. Place the windshield on the fairing behind the mask, inserting the studs of the clips through the top two fairing holes. Install the 5mm kep nut on the stud. See illustration.

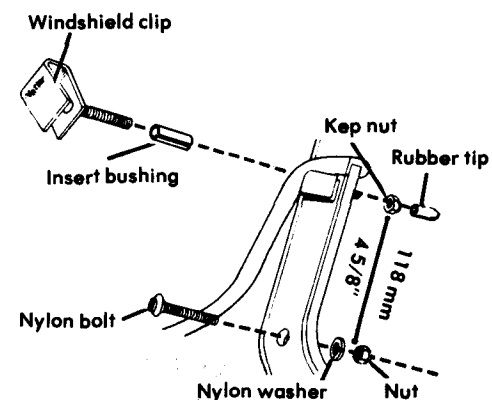

4. For the remaining six windshield mounting holes:

1. Insert a nylon bolt through the windshield and fairing.
2. Slide a small nylon washer onto each bolt.
3. Install a nut on the bolt but do not tighten at this time.

NOTE: The Windjammer V does not use the center mounting hole located behind the mask.

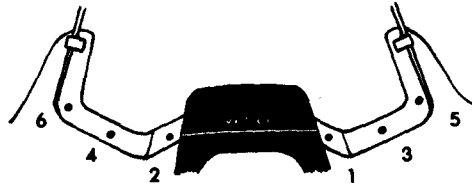

5. Tighten the bolts following the tightening sequence shown in the above illustration.

CAUTION: Tighten finger tight only.

6. If there is any clearance between the windshield and the clip, remove the clip nut and slide one of the provided bushings over the stud and into the fairing hole. This will center the stud in the

fairing hole. In some situations, a bushing may be necessary on both sides. See the following illustration.

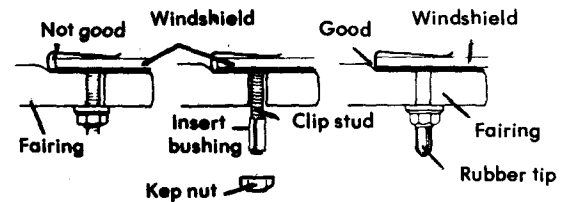

7. Install rubber tips over the exposed windshield clip studs.

NOTE: If the windshield does not fit tightly in the clips, the foam tape could work out from behind the windshield.

WARNING: Failure to install the windshield properly and maintain bolt tightness may result in windshield cracking. If the windshield ever becomes cracked, it should be replaced for safety reasons.

WINDSHIELD CLEANING INSTRUCTIONS

CAUTION: The surface of the windshield is easily scratched by hard rubbing or rough cloths. DO NOT clean the windshield with an abrasive cleaner, ethyl or methyl alcohol, gasoline or solvent, as these materials can cause deterioration of acrylic plastic.

WASH using a soft flannel cloth or chamois and a solution of mild soap or detergent and warm water. Rinse well.

DRY with a clean soft cloth or chamois.

REMOVE oil, grease, or tar with isopropyl alcohol or a good grade of either naphtha or kerosene.

MINOR SCRATCHES may be removed with plastic polish or automotive paste wax. Apply with a clean, soft flannel cloth or chamois. Allow to dry and polish gently with a dry flannel cloth or chamois.

FOR DEEPER SCRATCHES remove by sanding lightly with 400 grit "wet or

dry" paper. Then buff clear with a good grade of fine grit buffing compound and a clean soft muslin wheel. (A 1/4" electric drill has sufficient RPM's for this purpose.)

WARNING: Acrylic sheet is a combustible thermo-plastic. Exposure to excessive heat or flame should be avoided. Fire precautions appropriate for other flammable materials such as wood, should be observed.

WARNING: READ BEFORE RIDING

Your Vetter windshield is designed to protect you from the elements. It is not intended to protect you in a collision. All windshields can break which may result in rider injury.

Final Adjustments

OBJECTIVE

The fairing is now installed, but several details must be attended to before the installation is complete.

WARNING: Final clearance adjustment, if neglected, could result in dangerous interferences during use of the fairing and motorcycle. For your safety, make all necessary adjustments before using the newly installed fairing.

A. Check clearances with the fairing and windshield installed to be sure that the motorcycle's headlight nacelle does not rub, that your front brake does not engage when turned to full lock positions and that the external wiring harness does not catch anywhere on the motorcycle or fairing when the handlebars are turned. If any of these problems arise, the following steps should solve them.

1. If the clearance problem is the motorcycle's nacelle, first check the mounting instructions again to see if the nacelle should be removed and replaced by a wire bag. If the nacelle is to remain on the motorcycle, tilt the nacelle to obtain maximum clearance. If the nacelle still interferes, remove the bolts that hold it in position and move it farther back by replacing the bolts with smaller diameter bolts, washers and nuts.

2. Adjust your motorcycle's handlebars and mirrors, if necessary, to provide clearance for maximum turning radius. Loosen the bolts that hold the handlebars and rotate the handlebars towards the motorcycle, check clearance, then retighten bolts. After

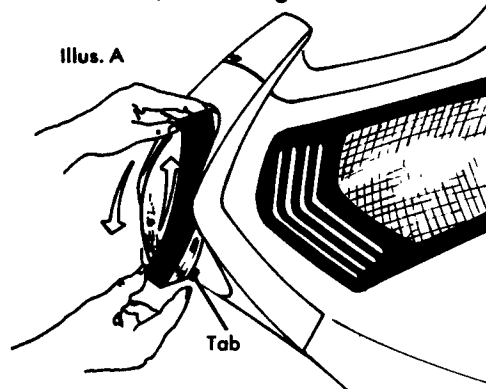

moving the handlebars and/or mirrors, check to insure that all controls are still accessible and that the mirrors can still be viewed through properly. Adjust if necessary.

B. Headlight Adjustments

1. Vertical - The fairing has been designed with an adjustable headlight for vertical positioning. The knob located in the center of the dash allows vertical positioning of the beam from the seat of the motorcycle. Readjustment may be necessary when carrying passengers or luggage.

WARNING: Do not adjust the headlight while operating the motorcycle.

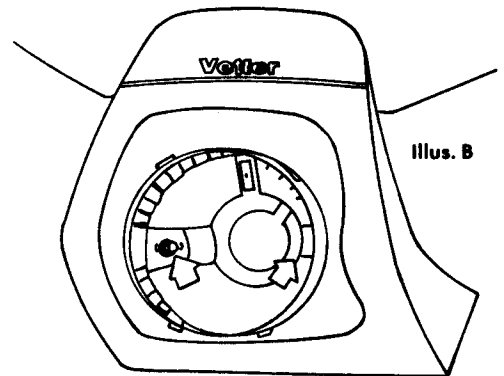

2. Horizontal adjustment

a. Remove the headlight as follows:

1. Using your thumb, push the tab (see illustration A) up until it disengages from the ring.

2. Turn the ring counter-clockwise to full unlock position and remove.

3. Remove the headlight from the nacelle and disconnect the wiring.

b. Loosen the bolt on the left side of the nacelle until the nacelle is just free to slide fore and aft. (See illustration B).

c. Reinstall the headlamp and position the nacelle for proper left to right beam position.

d. Carefully remove the headlamp without disturbing the nacelle position.

e. Tighten the nacelle bolt to lock the nacelle in position.

f. Reinstall the headlamp.

Troubleshooting

ELECTRICAL

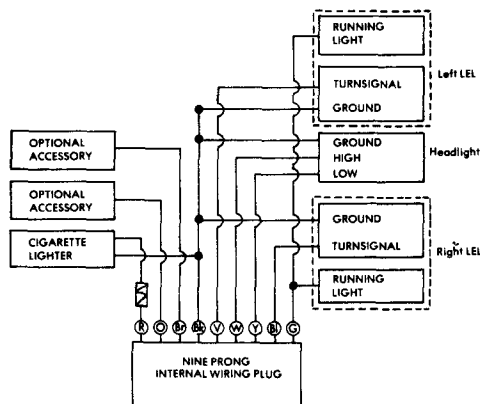

- R-Red** — Cigarette Lighter
- O-Orange** — Optional Accessory
- Br-Brown** — Optional Accessory
- Bk-Black** — Ground
- V-Violet** — Left Turnsignal
- W-White** — High Beam
- Y-Yellow** — Low Beam
- Bl-Blue** — Right Turnsignal
- G-Green** — Running Light

 **fuse 32V, 3 amp
slow blow**

If your problem is electrical, first check your color code to insure the proper wires have been connected. If your colors check out, the next step is to check the blue electrical connectors or bullet connectors (depending on your model bike) for good contact. This is

done by reversing the steps to connect them. Unsnap the lip of the blue connector and remove the metal tab with a pair of pliers.

Check both wires to see if the tab cut through the insulation and to the wire itself. Reinsert the wires. A loose bullet connector connection can be improved by unplugging the connector and making the female receptacle smaller by use of pliers and then reinstalling the bullet connector. If no power is getting to the fairing, check to see that the external wiring harness is making a good connection at the fairing's plug. If still no power is getting to the fairing, check the motorcycle's fuses and consult the motorcycle's owner's manual for determining the cause of fuse failure before replacing the fuse. If your headlamp is weak and your turnsignals don't function properly, your ground connection is probably not making good contact, or your battery is weak and needs to be serviced.

If there are any problems that cannot be solved by yourself or your dealer, contact the Customer Service Department of Vetter Corporation, Rantoul, Illinois 61866 (217) 893-9300.

FAIRING MOUNTING

The best answer for most problems is to re-read the mounting instructions carefully. Pay extra attention to notes pertaining to your specific model of

motorcycle. Brackets which do not bolt to the motorcycle frame may require movement up or down on the frame for a proper fit.

WINDSHIELD

If problems arise in mounting the windshield, don't panic. The windshield fits correctly if the proper procedures are followed. In the step-by-step assembly, the proper sequence for installing the

nylon bolts is given. Also, for reasons of structural strength, the windshield must be "preloaded" before it will fit properly.

Maintenance

Vetter fairings require little maintenance, but we recommend that you do make periodic checks. The mounting clamps, mounting bolts and the wind-

shield fasteners should be checked for tightness and adjustments made as necessary.

CLEANING AND WAXING THE FAIRING AND WINDSHIELD

When washing your fairing, use a mild detergent and warm water. Washing should be done with a soft cloth or sponge. Wash the windshield with the same solution, being careful not to rub or scratch the surface. Waxing the fairing is easy; furniture polish works as well as anything we have found. However, do not apply polish to the fairing's flat black mask. The finish of the mask will not accept any type of polish, and a discoloration will occur. To finish clean-

ing the windshield and remove any water spots, a plexiglas cleaner and polish should be used. A soft, flannel cloth is best for the job.

CAUTION: Do not use cleaners which contain methyl or ethyl alcohol.

CAUTION: Hydraulic fluid will damage your Vetter fairing. Never allow it to come in contact with your Windjammer V fairing.

STRUCTURAL REPAIR

Structural damage to the fairing may be repaired by using a Hotcha Fix Kit available through your dealer. The Hotcha Fix Kit includes Resin and Cream Hardener, plastic fairing material, stir sticks and instructions for using the kit. Regular automotive body putty can be used to prepare the surface of the

fairing for painting.

Because certain substances can attack the fairing body and cause it to deteriorate, we do not advise using any materials other than the Hotcha Fix Kit and automotive body putty.

IMPORTANT DRILLING INSTRUCTIONS

We do not recommend drilling any additional holes in the Windjammer V. However, if you plan on mounting accessory lights, brackets, etc., be sure to pad each side of the fairing with an oversized rubber washer first, then a regular

steel flat washer.

CAUTION: Failure to follow this procedure can result in failure at the mounting hole.

FAIRING STRIPING REMOVAL

When removing striping from the fairing, we suggest you use either our 3M Striping Removal Kit or use 3M Wood-grain and Striping Remover, part number, 18907; followed by 3M Adhesive Remover, part number, 18908. These products can be obtained at most paint and automotive stores that carry 3M products. Please follow the directions on the spray cans explicitly. These are very strong chemicals and can harm the paint if not used properly. We suggest removing the fairing from the motorcycle and trying the remover first on the hardware rail area. If the remover is defective and harms the paint, it will be in a place that will not show.

fairing. The 3M striping remover will cause damage to both the LEL and the mask if contact is made. Do not attempt to remove the graphics on the mask, or damage to the mask will result. Vetter Corporation cannot be responsible for 3M products.

When handling striping, do not crease or bend it. Always handle striping from the edges, never from the ends. Do not pull the backing off the striping with the expectations of reapplying it. Backing paper will NOT restick. If you have any questions on storing, handling, removal or application of striping that your dealer cannot answer, contact our Customer Service Department.

CAUTION: Be sure to shield the Leading Edge Lights and the mask, or remove them entirely from the

PAINTING INSTRUCTIONS

If you desire to repaint your fairing, we recommend that the following instructions be used.

1. Remove fairing logo decal and stripes.
2. Sand thoroughly with 320 grit wet sandpaper.
3. Resand with 400 grit sandpaper.

4. Dry thoroughly.
5. Spray with DuPont 100S Multi Purpose Primer.
6. Spray DuPont Weight Lifter Acrylic Enamel with 792S or 793S Hardener.
7. Install new vinyl decals.

QUARTZ HEADLIGHT

When handling the quartz bulb, handle it by the base only. Do not touch the glass, as this may cause premature failure. If the bulb is touched, clean using isopropyl alcohol with clean cotton.

CAUTION: Due to the limited charging ability of the 550cc and smaller motorcycles, the quartz headlight may have to be replaced by a standard sealed beam unit if the battery does not maintain a charge.

TONNEAU COVERS

The locking tonneau cover must not be removed while operating the motorcycle because of the possibility that the wind could catch it and bind the handlebars. If the cover is too snug or too loose, bend the lock blade or tab at the bottom of the tonneau cover to achieve the desired fit.

The pocket flap's double snaps are directional which necessitates that the cover be removed from the top down and put on from the bottom up. Care should be taken when removing the pocket tonneau cover so as not to pull the snaps out of the fairing or the cover itself.

TOWING

When trailering or towing your motorcycle it is advisable to remove the windshield from the fairing. Turbulent air

from the towing vehicle could possibly damage the windshield.

REPLACEMENT PARTS

We recommend that you always use Genuine Vetter Replacement Parts or their equivalent. Contact your local Vet-

ter dealer to purchase or order replacement parts.

CUSTOMER SERVICE

Any problems concerning installation or modification of the fairing should be referred to your dealer or the Customer Service Department, Vetter Corporation, Rantoul, IL 61866. We are here to serve you — (217) 893-9300. In order to provide the maximum amount of service to you and the dealer, it is necessary that you fill out the Owner's Registration

Card and promptly return it to Vetter Corporation. We also suggest you record your fairing's serial number here:

so you will have it should you ever need to contact us. It is located at the left interior plate where the wiring harness plugs in.

LIMITED WARRANTY VETTER CORPORATION PRODUCTS

This Warranty applies to products manufactured or distributed by Vetter Corporation, Rantoul, IL 61866, (217) 893-9300, and sold by Vetter Corporation or its authorized dealers within the United States, Puerto Rico, and the Virgin Islands. **It is given to the first retail purchaser only** and is not transferable to subsequent owners.

WARRANTY OBLIGATION: Vetter Corporation warrants that it, or one of its authorized dealers, will repair or, at its option, replace any part proven to be defective in factory material or workmanship within six (6) months (unlimited mileage) of the date of purchase. Parts repaired or replaced under this warranty are warranted only during the balance of the original warranty period.

THIS WARRANTY DOES NOT INCLUDE ANY LABOR CHARGES FOR TROUBLESHOOTING, REMOVAL OR INSTALLATION.

Exclusions from Coverage: 1. Any repairs or replacements or parts necessitated by misuse, negligence, fire, accident, damage caused by exposure to gasoline, brake fluid, harmful solvents and cleaners, paints, or repair material, use of unauthorized accessories, faulty installation, installation upon motorcycles or vehicles not listed in Vetter Corporation's retail and dealer catalog sheets, or improper or unreasonable maintenance are not covered. 2. This warranty does not cover "Totes" rain-boots.

DISCLAIMER OF CONSEQUENTIAL DAMAGES AND LIMITATIONS OF IMPLIED WARRANTIES: TO THE EXTENT THE LAW PERMITS, VETTER CORPORATION SHALL NOT BE LIABLE UNDER ANY CIRCUMSTANCES FOR LOSS OF USE OF THE PRODUCT, CONSEQUENTIAL OR INCIDENTAL DAMAGES. ANY IMPLIED WARRANTY ARISING UNDER LAW, INCLUDING THOSE OF MERCHANTABILITY AND FITNESS FOR A PARTICULAR PURPOSE IS LIMITED TO THE DURATION OF THIS LIMITED WARRANTY.

IMPORTANT: Some states do not allow limitations on how long an implied warranty lasts and/or limitations or exclusions of consequential or incidental damages, so the above limitations may not apply to you.

To Obtain Warranty Service: Information you must provide when filing claim: 1. Name, mailing address and telephone number. 2. Selling dealer's name and address. 3. Serial number on serialized products. 4. Model and year of motorcycle. 5. Date product was pur-

chased. 6. Date and mileage at failure. 7. Description of problem.

Steps to take: 1. Contact or take your product to an authorized Vetter dealer (preferably your selling dealer) at your expense. 2. If you are unable to obtain warranty service, or should your warranty claim be denied for reasons that you consider unjustifiable, contact the owner of your selling dealer. Normally, this should resolve your problem. However, if you require further assistance, write or call the Customer Service Department of Vetter Corporation, Rantoul, IL 61866. (217) 893-9300. At this point, you must be prepared to return the part in question to Vetter Corporation with all freight charges prepaid. The charges will be reimbursed to you if they total over \$5.00 (five dollars) and the warranty claim is honored. This warranty gives you specific legal rights and you may also have other rights which vary from state to state.

**September 30, 1979
Vetter Corporation**



Vetter Corporation, Rantoul, Illinois 61866 217/893-9300